

# Data Sheet

## Description

Avago Technologies’ ALM-GP003 is a GPS front-end module that combines a GPS FBAR filter with high-gain low-noise amplifier (LNA). The LNA uses Avago Technologies’ proprietary GaAs Enhancement-mode pHEMT process to achieve high gain with very low noise figure and high linearity. Noise figure distribution is very tightly controlled. A CMOS-compatible shutdown pin is included either for turning the LNA on/off or for current adjustment. The filter use Avago Technologies’ leading-edge FBAR filter for low GPS band insertion loss and exceptional rejection at Cellular, PCS and WLAN band frequencies.

The low noise figure and high gain, coupled with low current consumption make it suitable for use in critical low-power GPS applications or during low-battery situations.

## Component Image

Surface Mount 2.9 x 2.0 x 0.95 mm<sup>3</sup> 9-lead MCOB

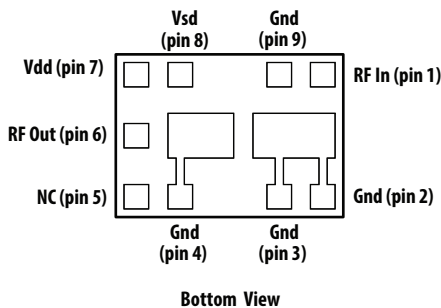
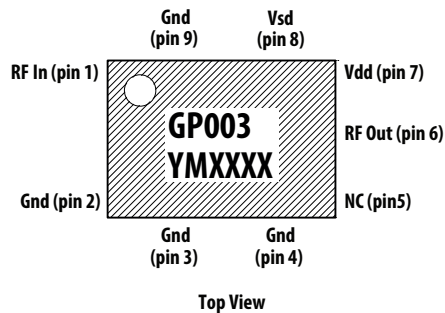

Note:  
Package marking provides orientation and identification  
"GP003" = Product Code  
"Y" = Year of manufacture  
"M" = Month of manufacture  
"XXXX" = Last 4 digits of lot number

## Features

- Operating temperature range -40 °C to +85 °C
- Very Low Noise Figure
- Exceptional Cell/PCS/WLAN-Band rejection
- Low external component count
- Fully-matched at RF input and RF output
- Shutdown current : < 1 μA
- CMOS compatible shutdown pin (SD)
- ESD : > 3 kV at RFin pin
- 2.9 x 2.0 x 0.95 mm size
- Adjustable bias current via single external resistor/voltage
- Lead-free and Halogen-free

## Specifications (Typical performance @ 25 °C)

At 1.575GHz, Vdd = 2.7V, Idd = 6mA

- Gain = 19.3 dB
- NF = 1.62 dB
- IIP3 = +1.5 dBm
- IP1 dB = -8 dBm
- S11 = -9.5 dB
- S22 = -13.5 dB
- Cell-Band Rejection: > 57 dBc
- PCS-Band Rejection: > 53 dBc
- WLAN-Band Rejection: > 52 dBc

## Application

- GPS Front-end Module

## Application Circuit

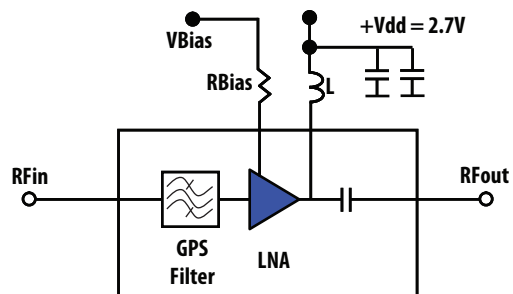

**Absolute Maximum Rating<sup>[1]</sup> T<sub>A</sub>=25 °C**

Symbol	Parameter	Units	Absolute Max.
V <sub>dd</sub>	Device Frain to Source Voltage <sup>[2]</sup>	V	4.5
I <sub>dd</sub>	Drain Current <sup>[2]</sup>	mA	15
P <sub>in,max</sub>	CW RF Input Power (V <sub>dd</sub> = 2.7V, I <sub>dd</sub> = 6mA)	dBm	13
P <sub>diss</sub>	Total Power Dissipation <sup>[4]</sup>	mW	54
T <sub>L</sub>	Operating Temperature	°C	-40 to 85
T <sub>j</sub>	Junction Temperature	°C	150
T <sub>STG</sub>	Storage Temperature	°C	-65 to 150

**Thermal Resistance<sup>[3]</sup>  
(V<sub>dd</sub> = 2.7V, I<sub>dd</sub> = 6mA), θ<sub>jc</sub> = 82.1°C/W**

Notes:

1. Operation of this device in excess of any of these limits may cause permanent damage.
2. Assuming DC quiescent conditions.
3. Thermal resistance measured using Infra-Red measurement technique.
4. Board (module belly) temperature T<sub>B</sub> is 25°C. Derate 4.2 mW/°C for T<sub>B</sub>>145.6°C.

## Electrical Specifications

$T_A = 25^\circ\text{C}$ , Freq = 1.575GHz, measured on demo board<sup>[1]</sup> unless otherwise specified – Typical Performance<sup>[1]</sup>

**Table 1. Performance at  $V_{dd} = V_{sd} = 2.7\text{V}$ ,  $I_{dd} = 6\text{mA}$  ( $R_2 = 4.7\text{kohm}$ , see Figure 1) nominal operating conditions**

Symbol	Parameter and Test Condition	Units	Min.	Typ	Max.
G	Gain	dB	17	19.3	–
NF	Noise Figure	dB	–	1.62	2.0
IP1dB	Input 1dB Compressed Power	dBm	–	-8	–
IIP3 <sup>[2]</sup>	Input 3 <sup>rd</sup> Order Intercept Point (2-tone @ $F_c \pm 2.5\text{MHz}$ )	dBm	–	+1.5	–
S11	Input Return Loss	dB	–	-9.5	–
S22	Output Return Loss	dB	–	-13.5	–
S12	Reverse Isolation	dB	–	-29	–
Cell Band Rejection	Worst-case relative to 1.575GHz within (827-928)MHz band	dBc	51	57	–
PCS Band Rejection	Worst-case relative to 1.575GHz within (1710-1980)MHz band	dBc	45	53	–
WLAN Band Rejection	Worst-case relative to 1.575GHz within (2400-2500)MHz band	dBc	43	52	–
IP1dB <sub>928MHz</sub>	Input 1dB gain compression interferer signal level at 928MHz	dBm	–	+39	–
IP1dB <sub>1980MHz</sub>	Input 1dB gain compression interferer signal level at 1980MHz	dBm	–	+44	–
IP1dB <sub>2400MHz</sub>	Input 1dB gain compression interferer signal level at 2400MHz	dBm	–	+43	–
I <sub>dd</sub>	Supply DC current at Shutdown (SD) voltage $V_{sd}=2.7\text{V}$	mA	–	6	11.5
I <sub>sh</sub>	Shutdown Current @ $V_{SD} = 0\text{V}$	uA	–	0.5	–

**Table 2. Performance at  $V_{dd} = V_{sd} = 1.8\text{V}$ ,  $I_{dd} = 4\text{mA}$  &  $V_{dd} = V_{sd} = 2.8\text{V}$ ,  $I_{dd} = 4\text{mA}$  (for  $R_2$  value, see Figure 2) nominal operating conditions**

Symbol	Parameter and Test Condition	Units	$V_{dd}=1.8\text{V}$ $I_{dd}=4\text{mA}$	$V_{dd}=2.8\text{V}$ $I_{dd}=4\text{mA}$
G	Gain	dB	17.5	18
NF	Noise Figure	dB	1.68	1.65
IP1dB	Input 1dB Compressed Power	dBm	-9.6	-9.5
IIP3 <sup>[2]</sup>	Input 3 <sup>rd</sup> Order Intercept Point (2-tone @ $F_c \pm 2.5\text{MHz}$ )	dBm	0	+1.0
S11	Input Return Loss	dB	-8	-8.5
S22	Output Return Loss	dB	-10	-10
S12	Reverse Isolation	dB	-27	-27
Cell Band Rejection	Worst-case relative to 1.575GHz within (827-928) MHz band	dBc	56	55
PCS Band Rejection	Worst-case relative to 1.575GHz within (1710-1980) MHz band	dBc	52	51
WLAN Band Rejection	Worst-case relative to 1.575GHz within (2400-2500) MHz band	dBc	51	50
IP1dB <sub>928MHz</sub>	Input 1dB gain compression interferer signal level at 928 MHz	dBm	+38	+38
IP1dB <sub>1980MHz</sub>	Input 1dB gain compression interferer signal level at 1980 MHz	dBm	+38	+38
IP1dB <sub>2400MHz</sub>	Input 1dB gain compression interferer signal level at 2400 MHz	dBm	+39	+39
I <sub>dd</sub>	Supply DC current at Shutdown (SD) voltage $V_{sd}=1.8\text{V}$	mA	4	4
I <sub>sh</sub>	Shutdown Current @ $V_{SD} = 0\text{V}$	uA	0.5	0.5

Notes:

1. Measurements at 1.575GHz obtained using schematic described in Figure 1 and Figure 2.
2. 1.575 GHz IIP3 test condition:  $F_{RF1} = 1572.5\text{MHz}$ ,  $F_{RF2} = 1577.5\text{MHz}$  with input power of -30 dBm per tone measured at the worst-case side band.

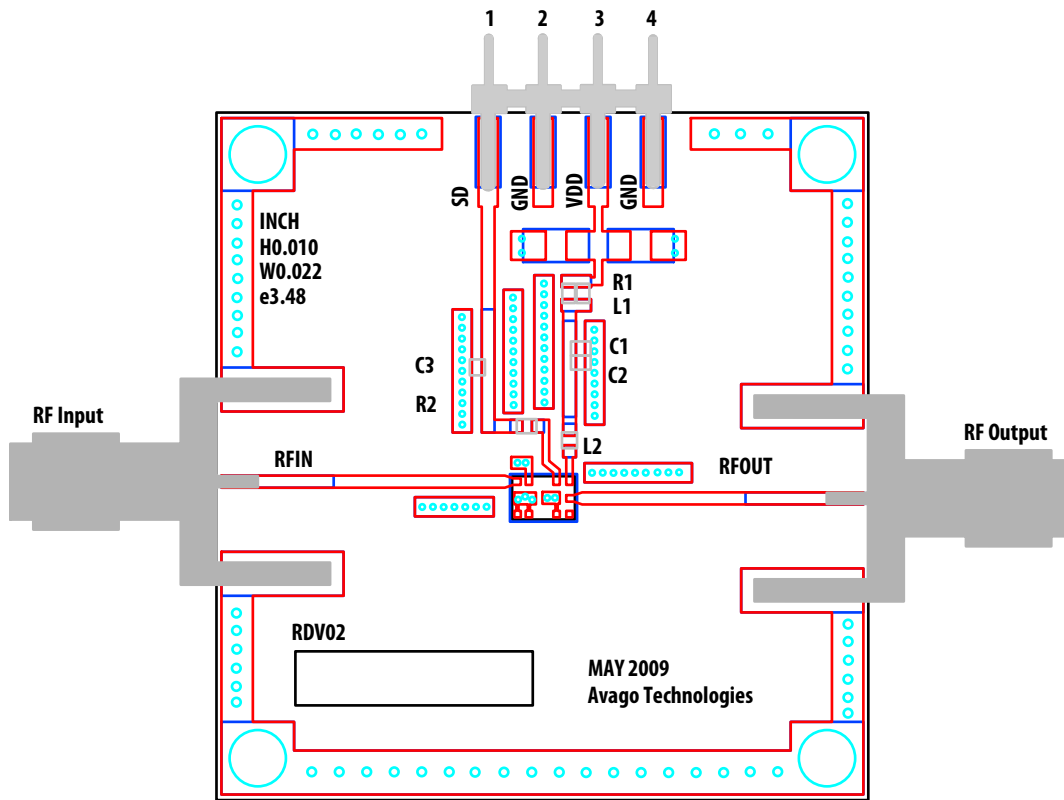

**DC Pin Configuration of 4-Pins connector**

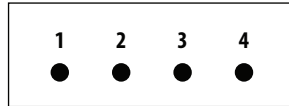

Pins 2, 4 = GND  
 Pin 3 = Vdd Supply  
 Pin 1 = Shutdown (SD)

Circuit Symbol	Size	Description	Part Number
L1	0402	22nH Inductor	(Taiyo Yuden HK100522NJ-T)
L2	0402	1.8nH Inductor	(Taiyo Yuden HK10051N8S-T)
C1	0402	0.1 uF Capacitor	(Kyocera CM05X5R104K10AH)
C2	0402	47pF Capacitor	(Kyocera CM05CH470J50AHF)
C3	0402	330pF Capacitor	(Kyocera CM05CH331J16AHF)
R1	0402	10 Ohm	(KOA RK73B1ETTB100J)
R2	0402	4.7 kohm	(KOA RK73B1ETTB472J)

Figure 1. Demoboard and application circuit components table

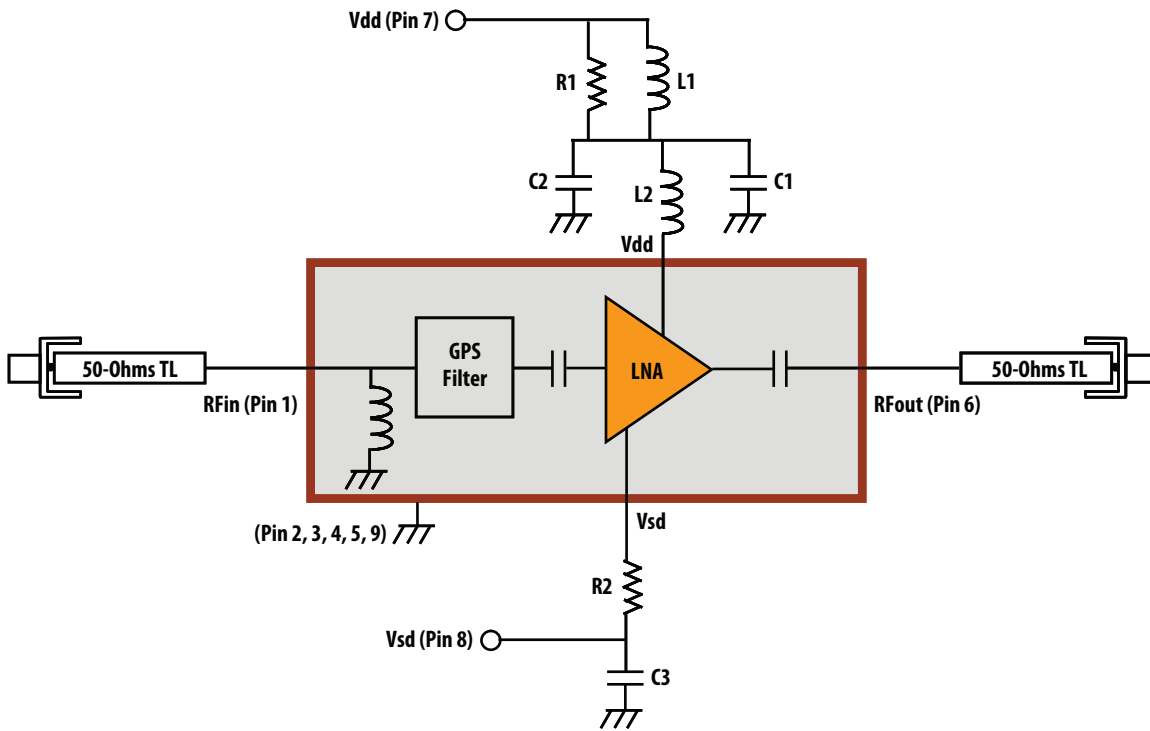

**Figure 2. Demoboard and application schematic diagram**

Notes:

- The module is fully matched at the input and output RF pins. Both these pins also have built-in coupling and DC-blocking capacitors. Best noise performance is obtained using high-Q wirewound inductors. This circuit demonstrates that low noise figures are obtainable with standard 0402 chip inductors.
- C2 and L2 form a matching network that affects the frequency response and linearity of the LNA, these can be tuned to optimize gain and return loss.
- L1 and R1 isolates the demoboard from external disturbances during measurement. It is not needed in actual application. Likewise, C1 and C3 mitigate the effect of external noise pickup on the Vdd and Vsd lines respectively. These components are not required in actual operation.
- Bias control is achieved by either varying the Vsd voltage with/without R2, or fixing the Vsd voltage to Vdd and adjusting R2 for the desired current.  $R2 = 4.7\text{Kohm}$  will result  $6\text{mA}$  when  $Vdd = Vsd = 2.7\text{V}$ .  $R2 = 2.7\text{Kohm}$  for  $4\text{mA}$  when  $Vdd = Vsd = 1.8\text{V}$  &  $R2 = 15\text{Kohm}$  for  $4\text{mA}$  when  $Vdd = Vsd = 2.8\text{V}$ .

## ALM-GP003 Typical Performance Curves at 25 °C

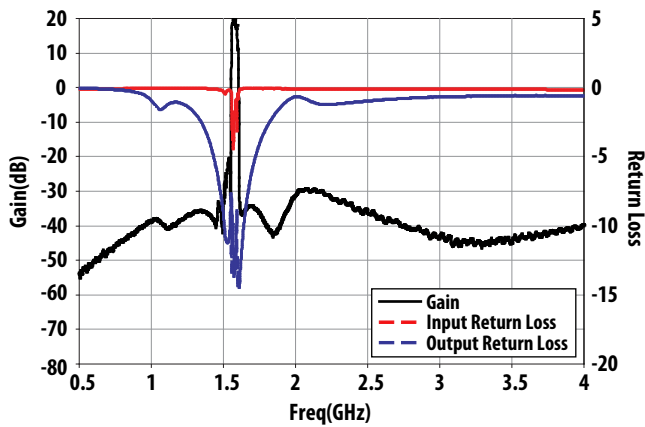

Figure 3a. Typical S-Parameter Plot @ Vdd = 2.7V, Idd = 6mA

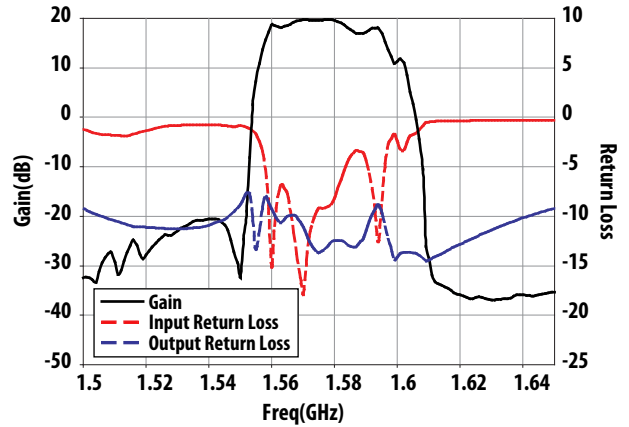

Figure 3b. Passband response of typical S-Parameter Plot @ Vdd = 2.7V, Idd = 6mA

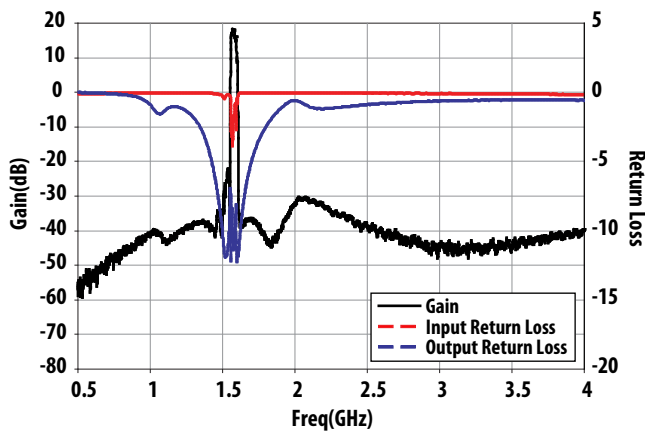

Figure 4a. Typical S-Parameter Plot @ Vdd = 1.8V, Idd = 4mA

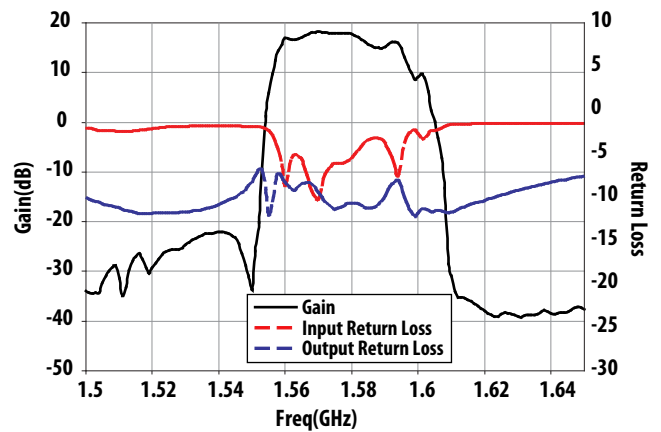

Figure 4b. Passband response of typical S-Parameter Plot @ Vdd = 1.8V, Idd = 4mA

**ALM-GP003 Typical Performance Curves at 25 °C, R2 = 4.7 kΩ**

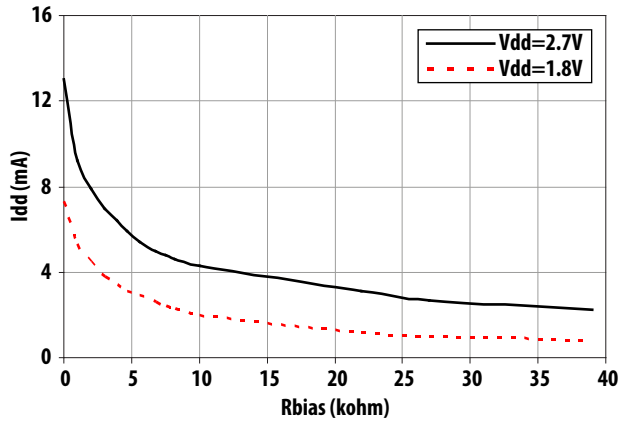

Figure 5. Idd vs Rbias at 25°C

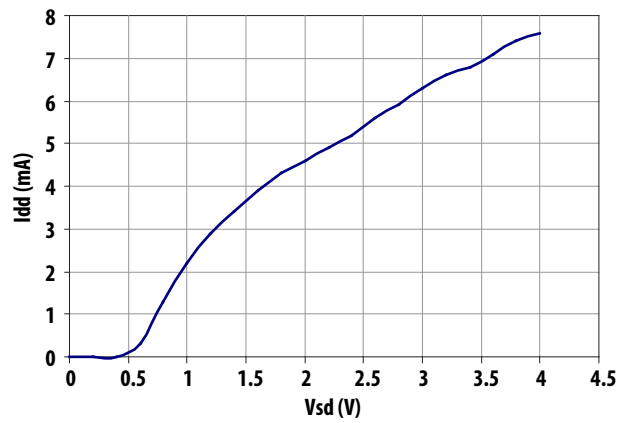

Figure 6. Idd vs Vsd for Vdd = 2.7V, R2 = 4.7kohm

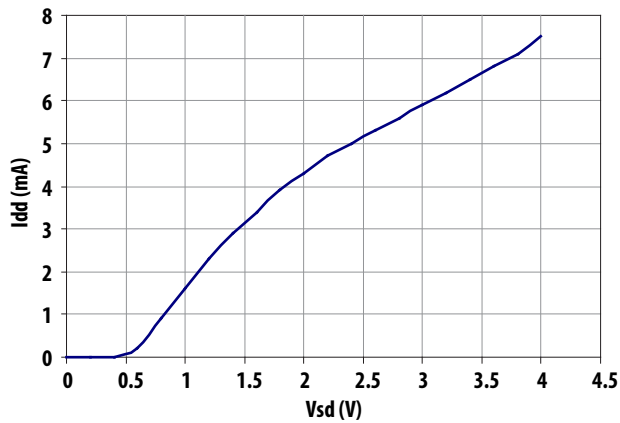

Figure 7. Idd vs Vsd for Vdd = 1.8V, R2 = 2.7kohm

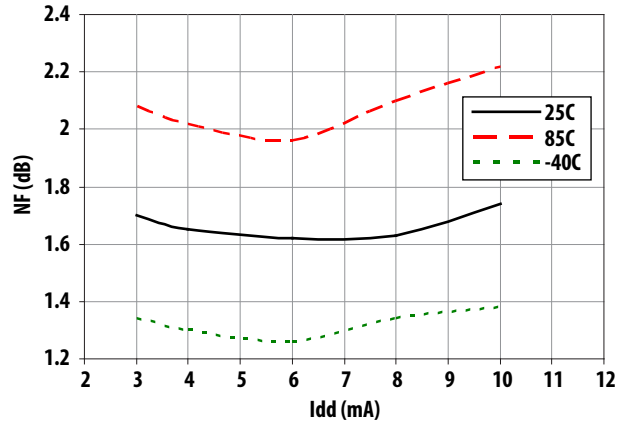

Figure 8. NF vs. Idd at Vdd = 2.7V

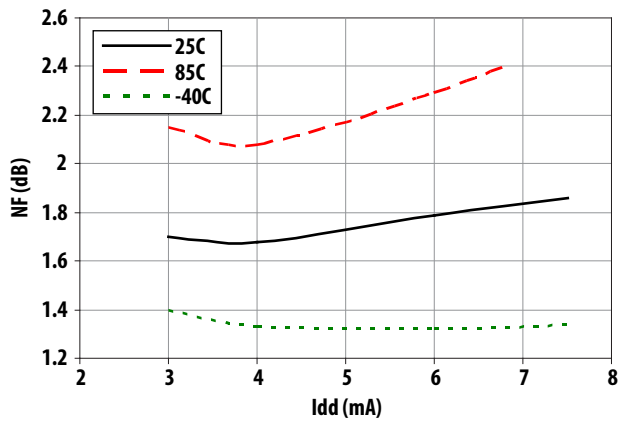

Figure 9. NF vs Idd at Vdd = 1.8V

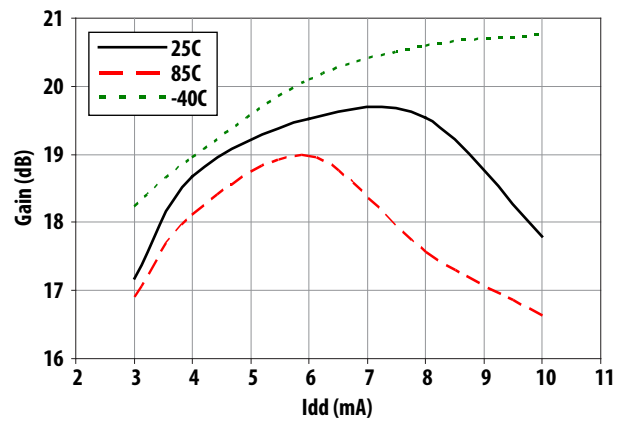

Figure 10. Gain vs. Idd at Vdd = 2.7V

ALM-GP003 Typical Performance Curves at 25 °C, R2 = 4.7 kΩ

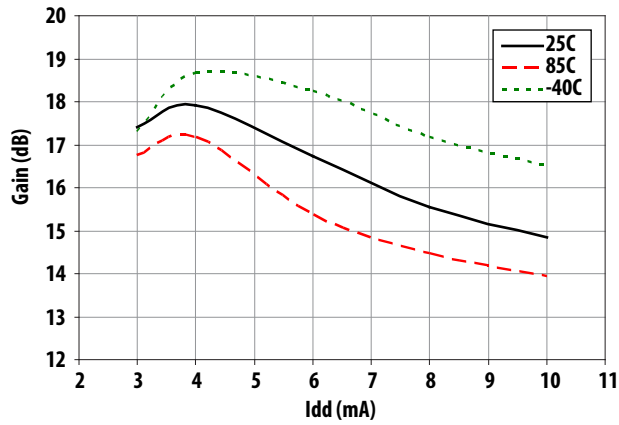

Figure 11. Gain vs. Idd at Vdd = 1.8V

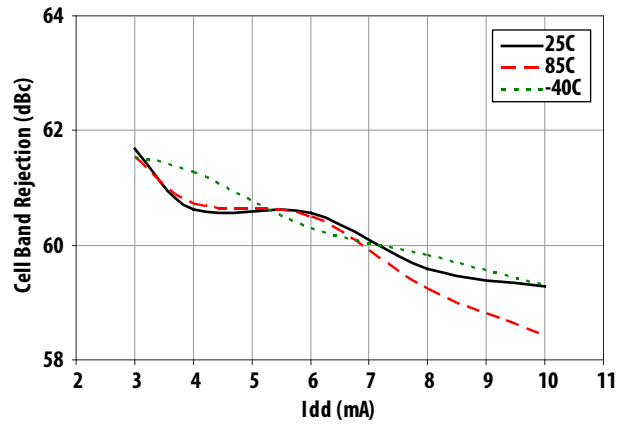

Figure 12. Cell band rejection vs. Idd at Vdd = 2.7V

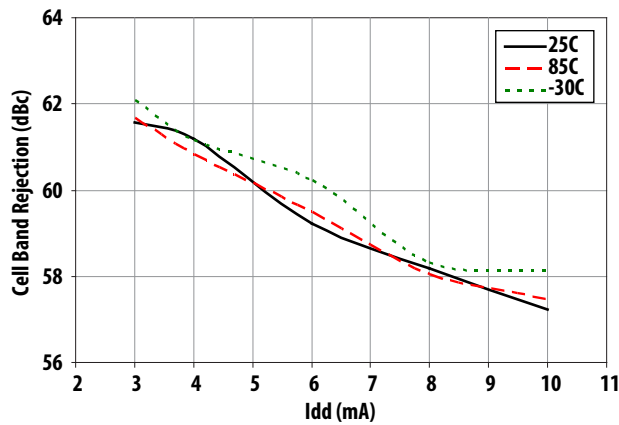

Figure 13. Cell band rejection vs. Idd at Vdd = 1.8V

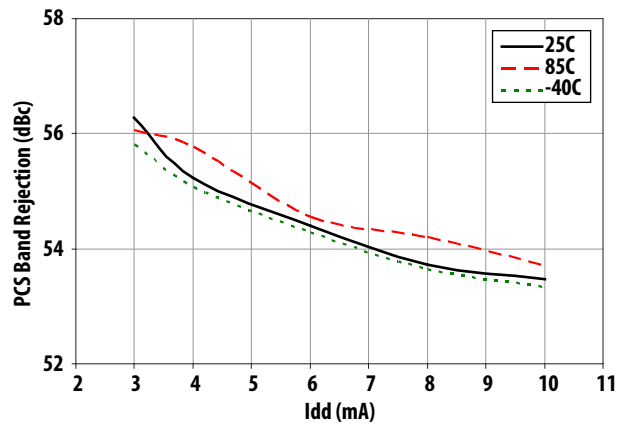

Figure 14. PCS band rejection vs. Idd at Vdd = 2.7V

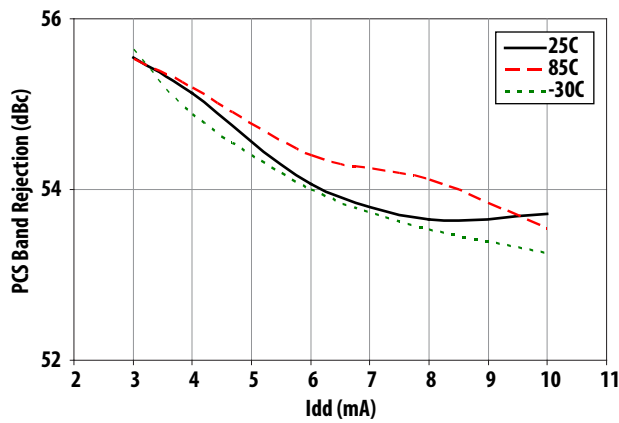

Figure 15. PCS band rejection vs. Idd at Vdd = 1.8V

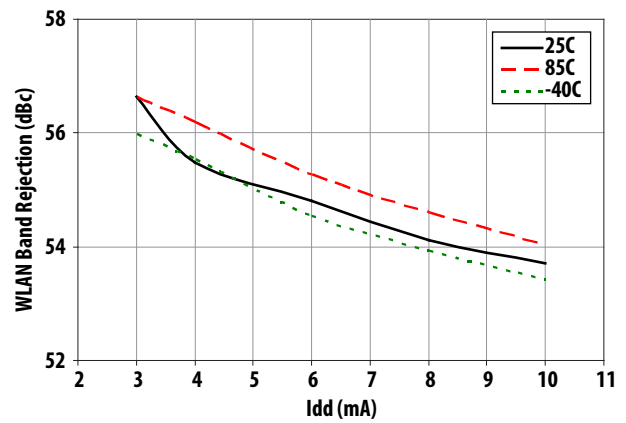

Figure 16. WLAN band rejection vs. Idd at Vdd = 2.7V



**ALM-GP003 Typical Performance Curves at 25 °C, R2 = 4.7 kΩ**

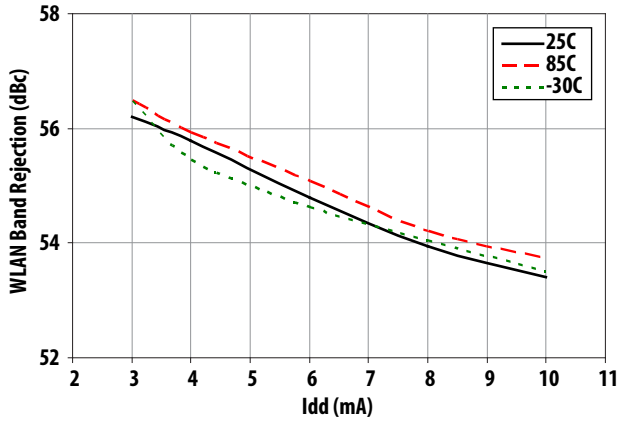

Figure 17. WLAN band rejection vs. Idd at Vdd = 1.8V

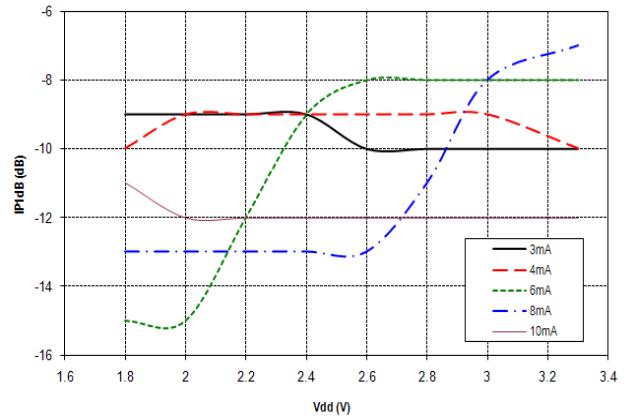

Figure 18. IP1dB vs. Vdd at 25°C

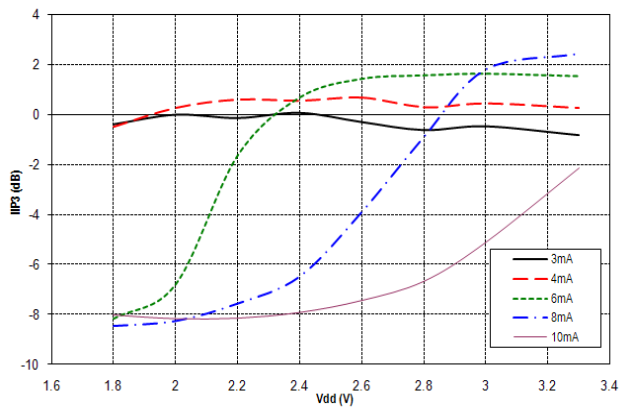

Figure 19. IIP3 vs. Vdd at 25°C

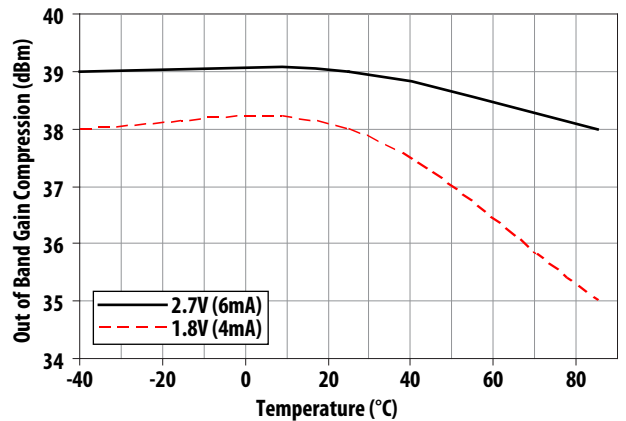

Figure 20. Input signal required at 928MHz interference signal to cause 1dB gain compression at 1.575GHz

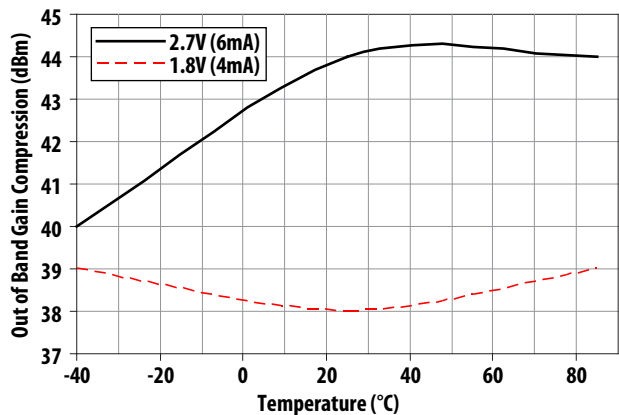

Figure 21. Input signal required at 1980MHz interference signal to cause 1dB gain compression at 1.575GHz

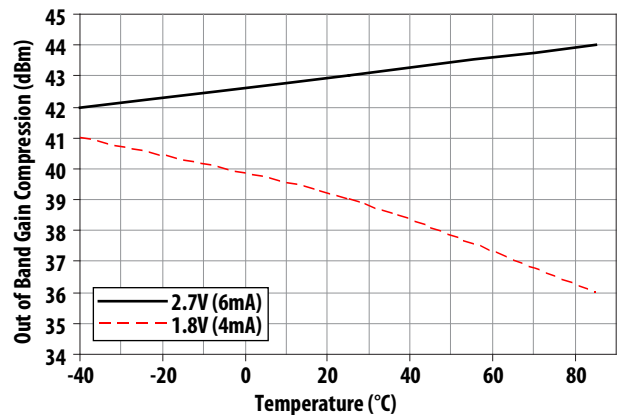

Figure 22. Input signal required at 2400MHz interference signal to cause 1dB gain compression at 1.575GHz

### ALM-GP003 Typical Performance Curves at 25 °C, R2 = 4.7 kΩ

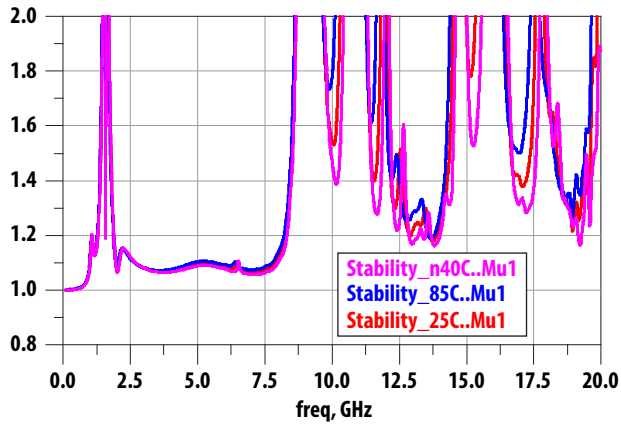

Figure 23. Edwards-Sinsky Output Stability Factor ( $\mu$ ) at Vdd = 2.7V

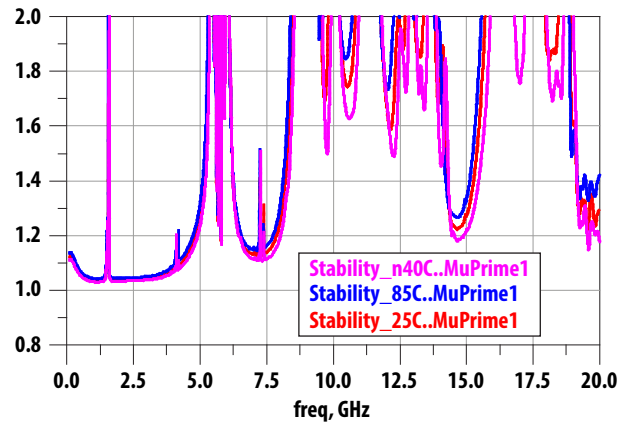

Figure 24. Edwards-Sinsky Input Stability Factor ( $\mu'$ ) at Vdd = 2.7V

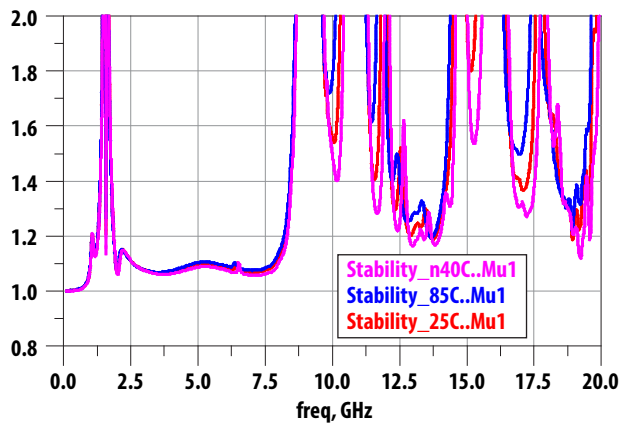

Figure 25. Edwards-Sinsky Output Stability Factor ( $\mu$ ) at Vdd = 1.8V

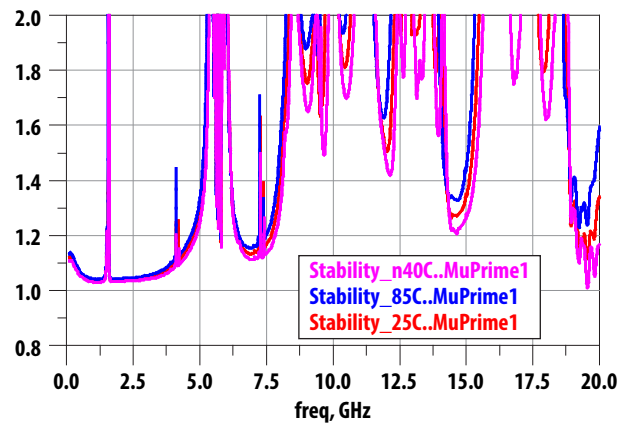

Figure 26. Edwards-Sinsky Input Stability Factor ( $\mu'$ ) at Vdd = 1.8V

### ALM-GP003 Scattering Parameter and Measurement Reference Planes

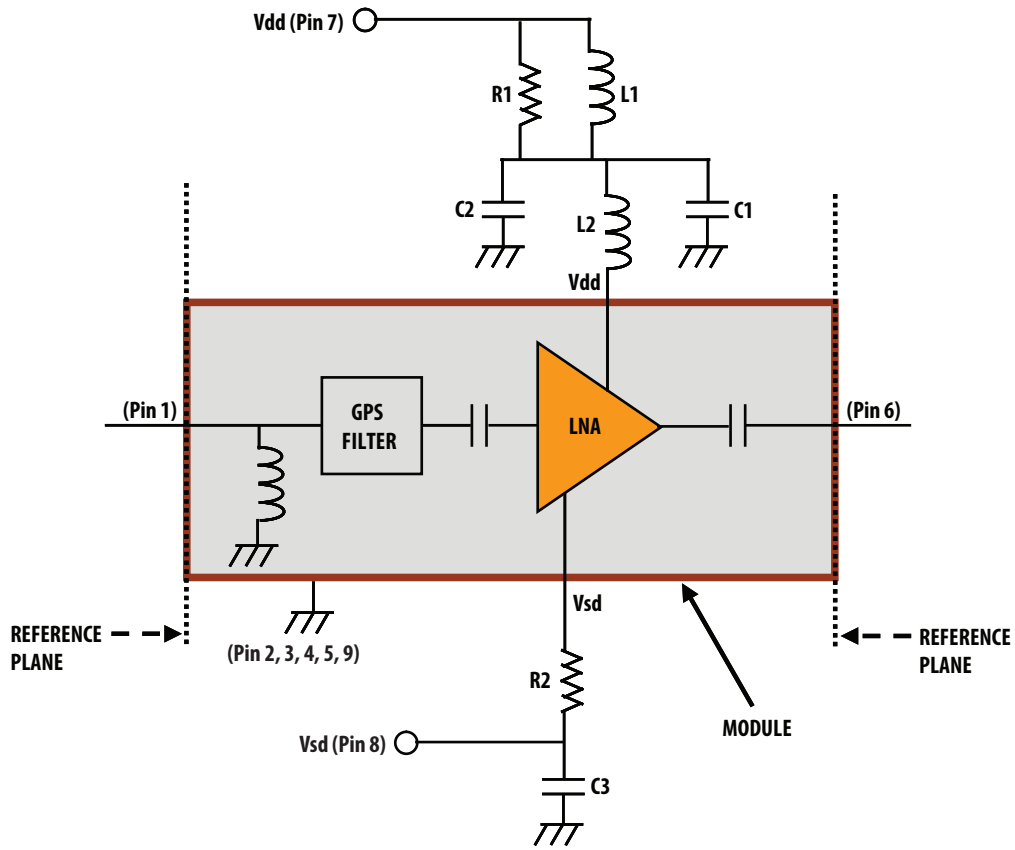

Figure 27. Scattering parameter measurement reference planes

## ALM-GP003 Typical Scattering Parameters at 25 °C, Vdd = 2.7V, Idd = 6mA

The S- and Noise Parameters are measured using a coplanar waveguide PCB with 10 mils Rogers® RO4350. Figure 27 shows the input and output reference planes. The circuit values are as indicated in Figure 1.

Freq (GHz)	S11	S11	S21	S21	S12	S12	S22	S22
	Mag. (dB)	Ang.	Mag. (dB)	Ang.	Mag. (dB)	Ang.	Mag. (dB)	Ang.
0.1	0.90	127.37	0.00	120.37	0.00	-82.40	1.00	-4.60
0.2	0.91	90.38	0.00	-24.66	0.00	123.51	1.00	-9.24
0.3	0.93	64.84	0.00	17.24	0.00	122.67	0.99	-13.92
0.4	0.95	46.42	0.00	5.69	0.00	36.92	0.99	-18.50
0.5	0.95	32.35	0.00	-8.72	0.00	138.61	0.99	-23.40
0.6	0.96	21.11	0.00	-18.53	0.00	69.29	0.99	-28.58
0.7	0.96	11.71	0.00	-28.54	0.00	118.56	0.99	-34.16
0.8	0.97	3.52	0.00	-36.62	0.00	41.88	0.99	-40.25
0.8275	0.97	-3.93	0.01	-46.68	0.00	51.42	0.98	-47.26
0.9	0.97	-5.92	0.01	-51.00	0.00	51.08	0.97	-49.42
1.0	0.97	-10.83	0.01	-62.26	0.00	42.54	0.94	-55.63
1.1	0.97	-18.84	0.01	-85.57	0.00	28.75	0.88	-58.23
1.2	0.97	-25.36	0.01	-77.54	0.00	24.49	0.92	-68.03
1.3	0.98	-32.32	0.01	-85.79	0.00	15.65	0.87	-83.31
1.4	0.98	-41.04	0.01	-94.59	0.00	-4.58	0.77	-104.67
1.5	0.88	-60.02	0.02	1.93	0.01	-39.52	0.57	-142.31
1.575	0.38	-69.26	9.45	-169.06	0.03	174.73	0.21	150.62
1.6	0.84	13.57	3.27	-133.28	0.01	-168.71	0.12	157.09
1.7	0.99	-35.68	0.02	-177.57	0.00	-74.12	0.38	52.17
1.8	0.99	-37.03	0.02	178.80	0.00	-75.60	0.41	46.69
1.885	0.99	-45.79	0.01	170.91	0.00	-96.42	0.65	12.47
1.9	0.99	-52.79	0.01	-136.49	0.00	-116.91	0.85	-12.51
2.0	0.99	-58.82	0.03	-149.24	0.00	-133.55	0.94	-34.30
2.1	0.99	-64.36	0.04	173.27	0.00	-142.26	0.88	-48.83
2.2	0.99	-69.90	0.03	145.75	0.00	-148.61	0.85	-55.23
2.3	0.99	-75.27	0.03	129.65	0.00	-150.64	0.86	-60.65
2.4	0.99	-80.54	0.02	119.00	0.00	-158.09	0.88	-66.20
2.5	0.99	-85.75	0.02	111.46	0.01	-163.55	0.89	-71.63
3.0	0.99	-110.11	0.01	100.70	0.01	167.80	0.95	-95.76
3.5	0.98	-130.93	0.01	130.14	0.01	150.08	0.97	-113.19
4.0	0.98	-148.37	0.01	139.66	0.01	136.34	0.98	-125.78
4.5	0.96	-165.25	0.01	128.82	0.01	123.10	0.99	-136.29
5.0	0.88	166.07	0.00	131.65	0.01	111.96	0.98	-147.49
6.0	0.49	-73.16	0.06	153.87	0.03	145.57	0.96	177.94
7.0	0.86	135.14	0.05	47.07	0.03	50.50	0.97	141.70
8.0	0.81	74.97	0.03	21.54	0.03	4.14	0.96	121.26
9.0	0.23	-37.83	0.10	-58.71	0.07	-128.81	0.64	100.01
10.0	0.33	-46.13	0.17	146.14	0.15	89.25	0.26	97.24
11.0	0.56	-137.13	0.06	-8.12	0.07	-73.43	0.77	156.59
12.0	0.27	-148.23	0.12	41.00	0.06	73.62	0.87	72.72
13.0	0.46	-129.23	0.13	-65.04	0.08	-52.72	0.90	47.40
14.0	0.78	157.89	0.03	-100.27	0.02	-66.53	0.96	53.91
15.0	0.80	119.17	0.04	-26.10	0.04	-19.61	0.95	61.13
16.0	0.64	102.79	0.15	-49.64	0.12	-43.23	0.81	43.12
17.0	0.37	43.63	0.39	-117.27	0.32	-109.51	0.65	-42.16
18.0	0.09	138.84	0.42	-178.97	0.36	-171.99	0.75	-60.43
19.0	0.75	68.84	0.40	110.25	0.35	116.05	0.87	-34.53
20.0	0.85	20.64	0.38	83.26	0.35	86.56	0.89	-16.65

**ALM-GP003 Typical Scattering Parameters at 25 °C, Vdd = 1.8V, Idd = 4mA**

Freq (GHz)	S11	S11	S21	S21	S12	S12	S22	S22
	Mag.	Ang.	Mag.	Ang.	Mag.	Ang.	Mag.	Ang.
0.1	0.90	127.32	0.00	94.14	0.00	-47.84	1.00	-4.57
0.2	0.91	90.34	0.00	-2.10	0.00	-107.15	1.00	-9.24
0.3	0.93	64.81	0.00	2.89	0.00	-156.72	0.99	-13.94
0.4	0.95	46.39	0.00	8.11	0.00	35.92	0.99	-18.50
0.5	0.95	32.31	0.00	-6.89	0.00	143.69	0.99	-23.40
0.6	0.96	21.09	0.00	-16.62	0.00	82.53	0.99	-28.60
0.7	0.96	11.67	0.00	-24.15	0.00	100.57	0.99	-34.18
0.8	0.97	3.47	0.00	-33.86	0.00	79.47	0.99	-40.30
0.8275	0.97	-4.01	0.01	-44.90	0.00	51.78	0.98	-47.35
0.9	0.97	-5.99	0.01	-47.28	0.00	51.83	0.97	-49.53
1.0	0.97	-10.92	0.01	-60.49	0.00	31.98	0.94	-55.83
1.1	0.97	-18.96	0.01	-83.38	0.00	31.73	0.88	-58.44
1.2	0.97	-25.52	0.01	-73.67	0.00	25.78	0.92	-68.40
1.3	0.98	-32.51	0.01	-82.53	0.00	12.80	0.87	-84.18
1.4	0.98	-41.28	0.01	-89.61	0.00	-6.47	0.76	-106.73
1.5	0.88	-60.32	0.02	-1.57	0.01	-41.17	0.54	-147.70
1.575	0.41	-78.94	7.95	-173.45	0.03	164.64	0.20	131.33
1.6	0.84	12.43	2.64	-136.63	0.01	-174.83	0.12	128.76
1.7	0.99	-35.96	0.02	-175.52	0.00	-76.78	0.43	43.37
1.8	0.99	-37.33	0.02	-179.18	0.00	-79.98	0.46	38.58
1.885	0.99	-46.13	0.01	176.29	0.00	-102.21	0.69	7.51
1.9	0.99	-53.14	0.01	-135.27	0.00	-120.48	0.87	-15.66
2.0	0.99	-59.20	0.03	-150.87	0.00	-135.87	0.95	-36.79
2.1	0.99	-64.79	0.03	168.18	0.00	-144.60	0.87	-49.90
2.2	0.99	-70.34	0.03	142.65	0.00	-148.59	0.86	-55.46
2.3	0.99	-75.71	0.02	128.27	0.00	-153.56	0.87	-61.03
2.4	0.99	-81.00	0.02	119.57	0.00	-159.62	0.89	-66.76
2.5	0.99	-86.22	0.01	113.42	0.00	-166.13	0.91	-72.29
3.0	0.99	-110.52	0.01	110.97	0.01	168.49	0.95	-96.41
3.5	0.98	-131.22	0.01	133.62	0.01	149.39	0.98	-113.77
4.0	0.98	-148.55	0.01	139.15	0.01	135.69	0.98	-126.29
4.5	0.96	-165.50	0.01	127.69	0.01	122.15	0.99	-136.77
5.0	0.88	165.46	0.00	122.42	0.01	111.77	0.98	-147.98
6.0	0.49	-73.91	0.06	151.64	0.03	145.07	0.96	177.43
7.0	0.86	133.56	0.05	44.44	0.03	49.76	0.97	141.51
8.0	0.81	74.08	0.03	17.50	0.03	2.66	0.96	121.11
9.0	0.21	-41.62	0.09	-91.72	0.06	-143.80	0.70	104.65
10.0	0.31	-47.91	0.18	122.11	0.13	77.64	0.15	75.36
11.0	0.56	-137.43	0.05	-23.74	0.06	-80.66	0.78	155.38
12.0	0.26	-146.22	0.11	40.59	0.07	72.65	0.87	72.48
13.0	0.46	-130.98	0.13	-65.47	0.08	-50.80	0.90	47.11
14.0	0.78	155.11	0.03	-100.99	0.02	-71.00	0.96	53.58
15.0	0.80	118.23	0.04	-29.47	0.04	-22.84	0.94	60.77
16.0	0.64	101.70	0.15	-52.25	0.13	-45.15	0.80	42.62
17.0	0.33	40.29	0.41	-122.82	0.35	-114.71	0.62	-43.62
18.0	0.16	128.82	0.43	171.30	0.38	178.20	0.72	-59.15
19.0	0.75	55.98	0.37	103.58	0.33	108.95	0.88	-34.50
20.0	0.81	13.70	0.35	78.38	0.34	81.34	0.89	-16.79

**ALM-GP003 Typical Noise Parameters at 25 °C,  
Freq = 1.575 GHz, Vdd = 2.7V, Idd = 6mA**

Freq (GHz)	Fmin (dB)	GAMMA OPT		
		Mag	Ang	Rn/50
1.575	1.43	0.23	-108	0.15

**ALM-GP003 Typical Noise Parameters at 25 °C,  
Freq = 1.575 GHz, Vdd = 1.8V, Idd = 4mA**

Freq (GHz)	Fmin (dB)	GAMMA OPT		
		Mag	Ang	Rn/50
1.575	1.57	0.17	-103	0.16

Notes:

The exceptional noise figure performance of the ALM-GP003 is due to its highly optimized design. In this regard, the Fmin of the ALM-GP003 shown above is locked down by the internal input pre-match. This allows the use of relatively inexpensive chip inductors for external matching.

**Part Number Ordering Information**

Part Number	Qty	Container
ALM-GP003-BLKG	100	7" Reel
ALM-GP003-TR1G	3000	13" Reel

**Package Dimensions**

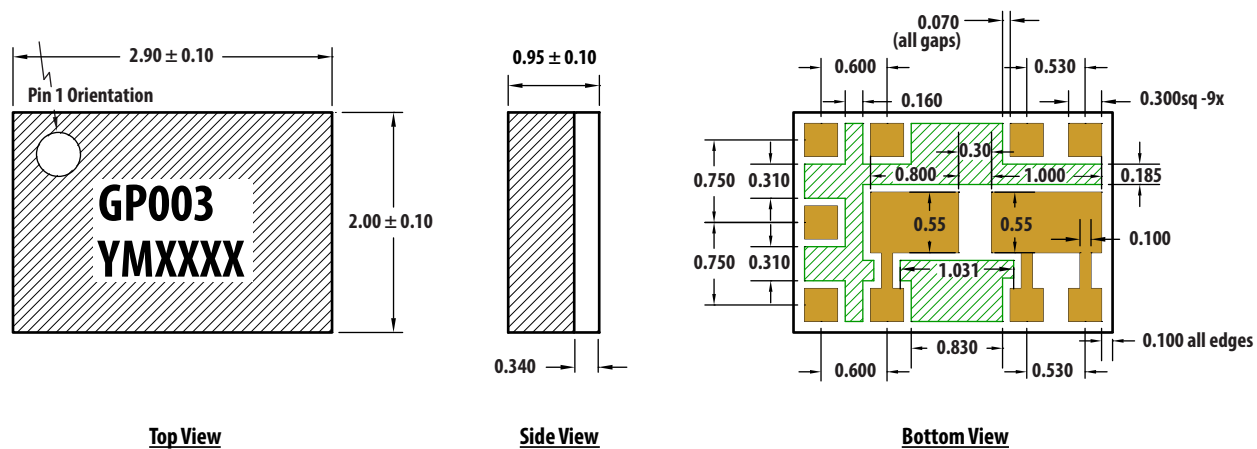

Notes:

1. All dimensions are in millimeters.
2. Dimensions are inclusive of plating.
3. Dimensions are exclusive of mold flash and metal burr.
4. Y refers to Year, W refers to Work Week.

## PCB Land Patterns and Stencil Design

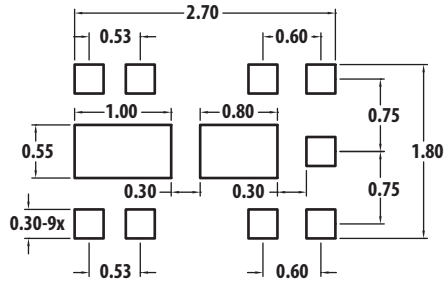

**Land Pattern**

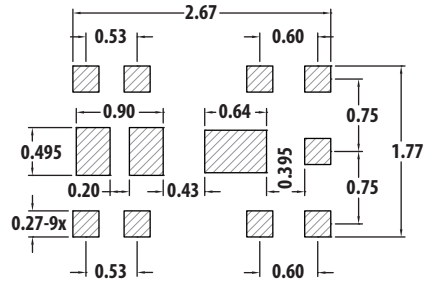

**Stencil Opening**

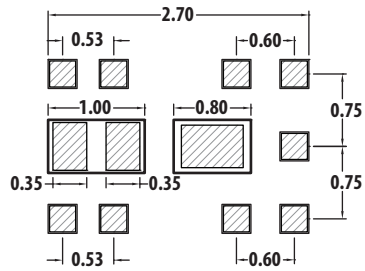

**Combination of Land Pattern & Stencil Opening**

Dimensions are in mm

## Device Orientation

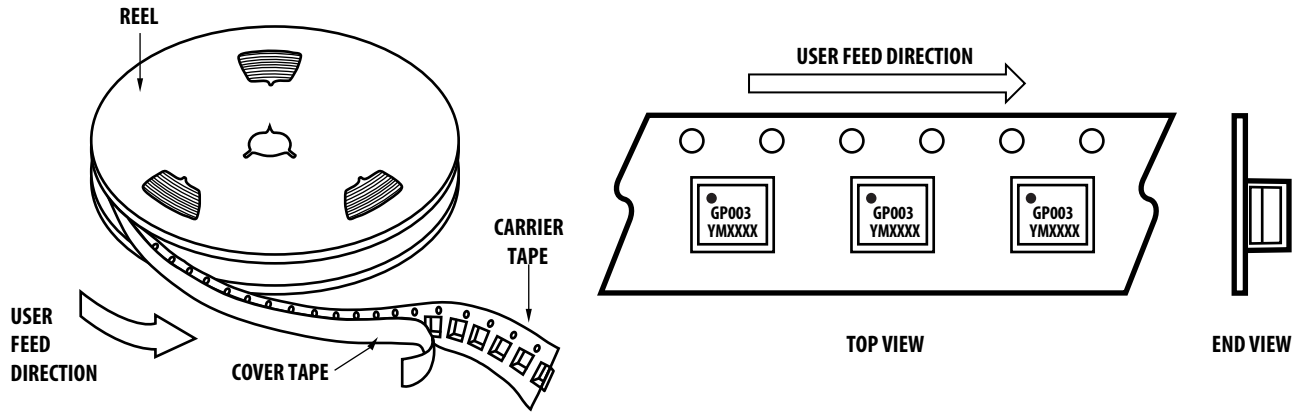

## Tape Dimensions

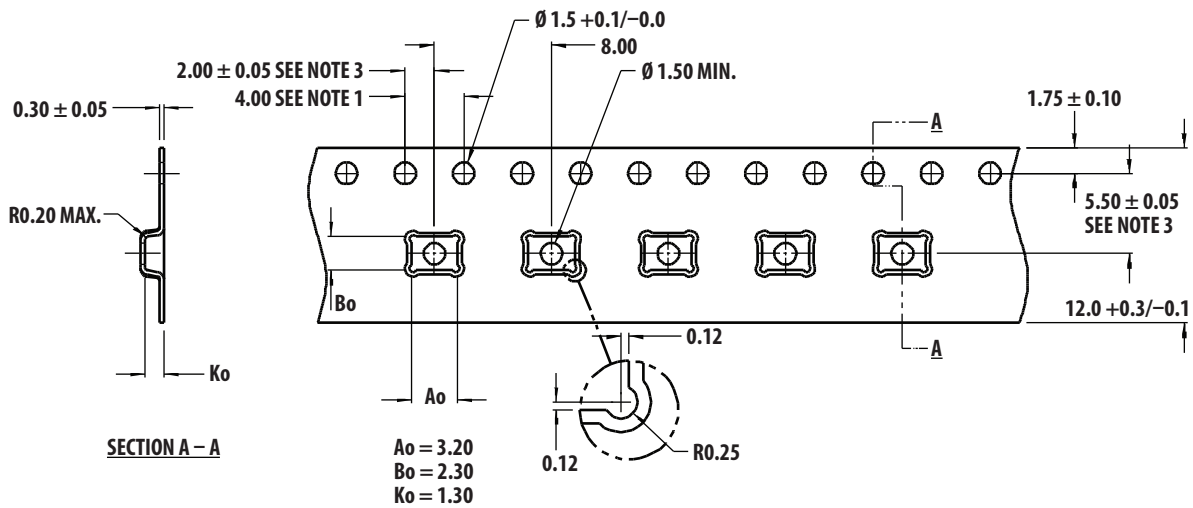

(All dimensions in mm)

### Notes:

1. 10 sprocket hole pitch cumulative tolerance  $\pm 0.2$
2. Camber in compliance with EIA 481
3. Pocket position relative to sprocket hole measured as true position of pocket, not pocket hole
4. Ao and Bo are calculated on a plane at a distance "R" above the bottom of the pocket.



